



[Maxim](#) > [Products](#) > [[Supervisors](#), [Voltage Monitors](#), [Sequencers](#)]

DS1705, DS1706

3.3 and 5.0 Volt MicroMonitor

Description

The DS1705/DS1706 3.3- or 5.0-Volt MicroMonitor monitors three vital conditions for a microprocessor: power supply, software execution, and external override. A precision temperature compensated reference and comparator circuit monitor the status of V_{CC} at the device and at an upstream point for maximum protection. When the sense input detects an out-of-tolerance condition a non-maskable interrupt is generated. As the voltage at the device degrades, an internal power fail signal is generated which forces the reset to an active state. When V_{CC} returns to an in-tolerance condition, the reset signal is kept in the active state for a minimum of 130ms to allow the power supply and processor to stabilize.

The second function the DS1705/DS1706 performs is pushbutton reset control. The DS1705/DS1706 debounces the pushbutton input and guarantees an active reset pulse width of 130ms minimum.

The third function is a watchdog timer. The DS1705/DS1706 has an internal timer that forces the WDO signal to the active state if the strobe input is not driven low prior to time-out.

Key Features

- Halts and restarts an out-of-control microprocessor
- Holds microprocessor in check during power transients
- Automatically restarts microprocessor after power failure
- Monitors pushbutton for external override
- Accurate 5%, 10% or 20% resets for 3.3V systems and 5% or 10% resets for 5.0V systems
- Eliminates the need for discrete components
- 3.3V 20% tolerance for use with 3.0V systems
- Pin-compatible with the MAXIM MAX705/MAX706 in 8-pin DIP, 8-pin SO, and μ SOP
- 8-pin DIP, 8-pin SO and 8-pin μ SOP packages
- Industrial temperature range -40°C to +85°C

Key Specifications: Supervisors (1 Monitored Voltage)

Part Number	Reset Threshold Range (V)	Active-Low Reset Output	Active-High Reset Output	Min. Reset Timeout Range	Watchdog Feature	Nom. Watchdog Timeout Range	Supervisor Features	Reset Thresh. Acc. (% @+25°C)	Max. I _{CC} (µA)
DS1705	3.3 to 5.5	Push-Pull	-	85ms to 300ms	Input/Output (WDI/WDO)	1s to 2s	Adjustable Reset Input Manual Reset Power Fail Comparator	2.5	60
DS1706	3.3 to 5.5	Push-Pull	-						60
DS1706L	3.3 to 5.5	-	Push-Pull						60
DS1706P	2.5 to 3.3	-	Push-Pull						50
DS1706R	2.5 to 3.3	Push-Pull	-						50
DS1706S	2.5 to 3.3	Push-Pull	-						50
DS1706T	2.5 to 3.3	Push-Pull	-						50

[See All Supervisors \(1 Monitored Voltage\) \(268\)](#)

Notes:

**This pricing is BUDGETARY, for comparing similar parts. Prices are in U.S. dollars and subject to change. Quantity pricing may vary substantially and international prices may differ due to local duties, taxes, fees, and exchange rates. For volume-specific prices and delivery, please see the [price and availability page](#) or contact an authorized distributor.

Application Notes

Application Note 245: [Adding Hysteresis to CPU Supervisor Voltage Sense Inputs Monitoring Upstream Voltage Supplies for Power-Fail Warnings - DS1705, DS1706](#)
 Application Note 3316: [Dallas Semiconductor Microprocessor Supervisor Selection Guide - DS1705, DS1706, DS1706, DS1706, DS1706, DS1706, DS1706](#)

Evaluation Kits

none

Reliability Reports

Reliability Report: [DS1705.pdf](#) [DS1706.pdf](#)

Software/Models

[DS1706T IBIS Model](#)

Ordering Information

Notes:

1. Other options and links for purchasing parts are listed at:
2. [Didn't Find What You Need?](#) Ask our applications engineers. Expert assistance in finding parts, usually within one business day.
3. Part number suffixes: T or T&R = tape and reel; + = RoHS/lead-free; # = RoHS/lead-exempt. More: See [Full Data Sheet](#) or [Part Naming Conventions](#).
4. * Some packages have variations, listed on the drawing. "PkgCode/Variation" tells which variation the product uses. Note that "+", "#", "-" in the part number suffix describes RoHS status. Package drawings may show a different suffix character.

Devices: 1-71 of 71

DS1705	Notes	Free Sample	Buy	Package: TYPE PINS FOOTPRINT DRAWING CODE/VAR *	Temp	RoHS/Lead-Free? Materials Analysis
DS1705EPA	5V-5% Monitor			PDIP; 8 pin; Dwg: 21-0043 (PDF) Use pkgcode/variation: P8-7*	-40°C to +85° C	RoHS/Lead-Free: No Materials Analysis
DS1705EPA+				PDIP; 8 pin; Dwg: 21-0043 (PDF) Use pkgcode/variation: P8+7*	-40°C to +85° C	RoHS/Lead-Free: Lead Free Materials Analysis
DS1705ESA+				SOIC; 8 pin; Dwg: 21-0041 (PDF) Use pkgcode/variation: S8+2*	-40°C to +85° C	RoHS/Lead-Free: Lead Free Materials Analysis
DS1705ESA	5V-5% Monitor			SOIC; 8 pin; Dwg: 21-0041 (PDF) Use pkgcode/variation: S8-2*	-40°C to +85° C	RoHS/Lead-Free: No Materials Analysis
DS1705ESA/T&R	5V-5%			SOIC; 8 pin; Dwg: 21-0041 (PDF) Use pkgcode/variation: S8-2*	-40°C to +85° C	RoHS/Lead-Free: No Materials Analysis
DS1705ESA+T&R	5V-5%	T&R		SOIC; 8 pin; Dwg: 21-0041 (PDF) Use pkgcode/variation: S8+2*	-40°C to +85° C	RoHS/Lead-Free: Lead Free Materials Analysis
DS1705EUA+				uMAX; 8 pin; Dwg: 21-0036 (PDF) Use pkgcode/variation: U8+1*	-40°C to +85° C	RoHS/Lead-Free: Lead Free Materials Analysis
DS1705EUA/T&R	5V-5%			uMAX; 8 pin; Dwg: 21-0036 (PDF) Use pkgcode/variation: U8-1*	-40°C to +85° C	RoHS/Lead-Free: No Materials Analysis

DS1706EPA	5V-10% Monitor			PDIP; 8 pin; Dwg: 21-0043 (PDF) Use pkgcode/variation: P8-7*	-40°C to +85° C	RoHS/Lead-Free: No Materials Analysis
DS1706SEPA+				PDIP; 8 pin; Dwg: 21-0043 (PDF) Use pkgcode/variation: P8+7*	-40°C to +85° C	RoHS/Lead-Free: Lead Free Materials Analysis
DS1706PESA/T&R/				SOIC; 8 pin; Dwg: 21-0041 (PDF) Use pkgcode/variation: S8-2*	-40°C to +85° C	RoHS/Lead-Free: No Materials Analysis
DS1706SESA/T&R/C01				SOIC; 8 pin; Dwg: 21-0041 (PDF) Use pkgcode/variation: S8-2*	-40°C to +85° C	RoHS/Lead-Free: No Materials Analysis
DS1706PESA/T&R	3.3V-20%			SOIC; 8 pin; Dwg: 21-0041 (PDF) Use pkgcode/variation: S8-2*	-40°C to +85° C	RoHS/Lead-Free: No Materials Analysis
DS1706PESA+				SOIC; 8 pin; Dwg: 21-0041 (PDF) Use pkgcode/variation: S8+2*	-40°C to +85° C	RoHS/Lead-Free: Lead Free Materials Analysis
DS1706SESA+T&R	3.3V-10%			SOIC; 8 pin; Dwg: 21-0041 (PDF) Use pkgcode/variation: S8+4*	-40°C to +85° C	RoHS/Lead-Free: Lead Free Materials Analysis
DS1706ESA	5V-10% Monitor			SOIC; 8 pin; Dwg: 21-0041 (PDF) Use pkgcode/variation: S8-2*	-40°C to +85° C	RoHS/Lead-Free: No Materials Analysis
DS1706TESA+T&R	3.3V-5%			SOIC; 8 pin; Dwg: 21-0041 (PDF) Use pkgcode/variation: S8+4*	-40°C to +85° C	RoHS/Lead-Free: Lead Free Materials Analysis
DS1706ESA/T&R	5V-10%			SOIC; 8 pin; Dwg: 21-0041 (PDF) Use pkgcode/variation: S8-2*	-40°C to +85° C	RoHS/Lead-Free: No Materials Analysis
DS1706LESA+T&R	5V-5%			SOIC; 8 pin; Dwg: 21-0041 (PDF) Use pkgcode/variation: S8+2*	-40°C to +85° C	RoHS/Lead-Free: Lead Free Materials Analysis
DS1706TESA+	3.3V-5%			SOIC; 8 pin; Dwg: 21-0041 (PDF) Use pkgcode/variation: S8+4*	-40°C to +85° C	RoHS/Lead-Free: Lead Free Materials Analysis
DS1706ESA+				SOIC; 8 pin; Dwg: 21-0041 (PDF) Use pkgcode/variation: S8+2*	-40°C to +85° C	RoHS/Lead-Free: Lead Free Materials Analysis

DS1706RESA+T&R	3.3V-20%			SOIC; 8 pin; Dwg: 21-0041 (PDF) Use pkgcode/variation: S8+2*	-40°C to +85° C	RoHS/Lead-Free: Lead Free Materials Analysis
DS1706SESA+				SOIC; 8 pin; Dwg: 21-0041 (PDF) Use pkgcode/variation: S8+2*	-40°C to +85° C	RoHS/Lead-Free: Lead Free Materials Analysis
DS1706LESA+				SOIC; 8 pin; Dwg: 21-0041 (PDF) Use pkgcode/variation: S8+2*	-40°C to +85° C	RoHS/Lead-Free: Lead Free Materials Analysis
DS1706PESA+T&R	3.3V-20%			SOIC; 8 pin; Dwg: 21-0041 (PDF) Use pkgcode/variation: S8+4*	-40°C to +85° C	RoHS/Lead-Free: Lead Free Materials Analysis
DS1706ESA+T&R	5V-10%			SOIC; 8 pin; Dwg: 21-0041 (PDF) Use pkgcode/variation: S8+4*	-40°C to +85° C	RoHS/Lead-Free: Lead Free Materials Analysis
DS1706RESA	3.3V-20% Monitor			SOIC; 8 pin; Dwg: 21-0041 (PDF) Use pkgcode/variation: S8-2*	-40°C to +85° C	RoHS/Lead-Free: No Materials Analysis
DS1706SESA	3.3V-10% Monitor			SOIC; 8 pin; Dwg: 21-0041 (PDF) Use pkgcode/variation: S8-2*	-40°C to +85° C	RoHS/Lead-Free: No Materials Analysis
DS1706SESA/T&R	3.3V-10%			SOIC; 8 pin; Dwg: 21-0041 (PDF) Use pkgcode/variation: S8-2*	-40°C to +85° C	RoHS/Lead-Free: No Materials Analysis
DS1706PESA	3.3V-20% Monitor			SOIC; 8 pin; Dwg: 21-0041 (PDF) Use pkgcode/variation: S8-2*	-40°C to +85° C	RoHS/Lead-Free: No Materials Analysis
DS1706TESA	3.3V-5% Monitor			SOIC; 8 pin; Dwg: 21-0041 (PDF) Use pkgcode/variation: S8-2*	-40°C to +85° C	RoHS/Lead-Free: No Materials Analysis
DS1706TESA/T&R	3.3V-5%			SOIC; 8 pin; Dwg: 21-0041 (PDF) Use pkgcode/variation: S8-2*	-40°C to +85° C	RoHS/Lead-Free: No Materials Analysis
DS1706LESA/T&R	5V-5%			SOIC; 8 pin; Dwg: 21-0041 (PDF) Use pkgcode/variation: S8-2*	-40°C to +85° C	RoHS/Lead-Free: No Materials Analysis
DS1706RESA+				SOIC; 8 pin; Dwg: 21-0041 (PDF) Use pkgcode/variation: S8+2*	-40°C to +85° C	RoHS/Lead-Free: Lead Free Materials Analysis

DS1706LESA	5V-5% Monitor			SOIC; 8 pin; Dwg: 21-0041 (PDF) Use pkgcode/variation: S8-2*	-40°C to +85° C	RoHS/Lead-Free: No Materials Analysis
DS1706LEUA+				uMAX; 8 pin; Dwg: 21-0036 (PDF) Use pkgcode/variation: U8+1*	-40°C to +85° C	RoHS/Lead-Free: Lead Free Materials Analysis
DS1706TEUA+				uMAX; 8 pin; Dwg: 21-0036 (PDF) Use pkgcode/variation: U8+1*	-40°C to +85° C	RoHS/Lead-Free: Lead Free Materials Analysis
DS1706SEUA+				uMAX; 8 pin; Dwg: 21-0036 (PDF) Use pkgcode/variation: U8+1*	-40°C to +85° C	RoHS/Lead-Free: Lead Free Materials Analysis
DS1706PEUA+				uMAX; 8 pin; Dwg: 21-0036 (PDF) Use pkgcode/variation: U8+1*	-40°C to +85° C	RoHS/Lead-Free: Lead Free Materials Analysis
DS1706TEUA+T&R	3.3V-5%			uMAX; 8 pin; Dwg: 21-0036 (PDF) Use pkgcode/variation: U8+1*	-40°C to +85° C	RoHS/Lead-Free: Lead Free Materials Analysis
DS1706EUA+				uMAX; 8 pin; Dwg: 21-0036 (PDF) Use pkgcode/variation: U8+1*	-40°C to +85° C	RoHS/Lead-Free: Lead Free Materials Analysis
DS1706REUA	3.3V-20% Monitor			uMAX; 8 pin; Dwg: 21-0036 (PDF) Use pkgcode/variation: U8-1*	-40°C to +85° C	RoHS/Lead-Free: No Materials Analysis
DS1706PEUA/T&R	3.3V-20%			uMAX; 8 pin; Dwg: 21-0036 (PDF) Use pkgcode/variation: U8-1*	-40°C to +85° C	RoHS/Lead-Free: No Materials Analysis
DS1706PEUA	3.3V-20% Monitor			uMAX; 8 pin; Dwg: 21-0036 (PDF) Use pkgcode/variation: U8-1*	-40°C to +85° C	RoHS/Lead-Free: No Materials Analysis
DS1706LEUA/T&R	5V-5%			uMAX; 8 pin; Dwg: 21-0036 (PDF) Use pkgcode/variation: U8-1*	-40°C to +85° C	RoHS/Lead-Free: No Materials Analysis
DS1706LEUA	5V-5% Monitor			uMAX; 8 pin; Dwg: 21-0036 (PDF) Use pkgcode/variation: U8-1*	-40°C to +85° C	RoHS/Lead-Free: No Materials Analysis
DS1706EUA/T&R	5V-10%			uMAX; 8 pin; Dwg: 21-0036 (PDF) Use pkgcode/variation: U8-1*	-40°C to +85° C	RoHS/Lead-Free: No Materials Analysis

FEATURES

- Halts and restarts an out-of-control microprocessor
- Holds microprocessor in check during power transients
- Automatically restarts microprocessor after power failure
- Monitors pushbutton for external override
- Accurate 5%, 10% or 20% resets for 3.3V systems and 5% or 10% resets for 5.0V systems
- Eliminates the need for discrete components
- 3.3V 20% tolerance for use with 3.0V systems
- Pin-compatible with the MAXIM MAX705/MAX706 in 8-pin DIP, 8-pin SOIC, and μ -SOP
- 8-pin DIP, 8-pin SOIC and 8-pin μ -SOP packages
- Industrial temperature range -40°C to +85°C

PIN ASSIGNMENT

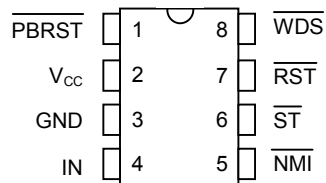

8-Pin DIP (300-mil)

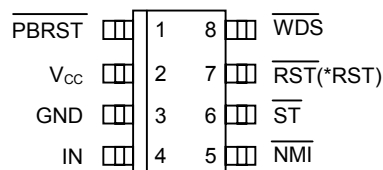

8-Pin SOIC (150-mil)

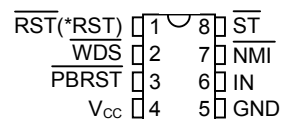

8-Pin μ -SOP (118-mil)

See Mech. Drawings Section on website

DS1705 and DS1706_R/S/T
(*DS1706L and DS1706P)

PIN DESCRIPTION

PBRST	- Pushbutton Reset Input
V _{CC}	- Power Supply
GND	- Ground
IN	- Input
NMI	- Non-maskable Interrupt
ST	- Strobe Input
RST	- Active Low Reset Output
*RST	- Active High Reset Output (DS1706P and DS1706L only)
WDS	- Watchdog Status Output

DESCRIPTION

The DS1705/DS1706 3.3- or 5.0-Volt MicroMonitor monitors three vital conditions for a microprocessor: power supply, software execution, and external override. A precision temperature compensated reference and comparator circuit monitor the status of V_{CC} at the device and at an upstream point for maximum protection. When the sense input detects an out-of-tolerance condition, a non-maskable interrupt is generated. As the voltage at the device degrades, an internal power fail signal is generated which forces

the reset to an active state. When V_{CC} returns to an in-tolerance condition, the reset signal is kept in the active state for a minimum of 130 ms to allow the power supply and processor to stabilize.

The second function the DS1705/DS1706 performs is pushbutton reset control. The DS1705/DS1706 debounces the pushbutton input and guarantees an active reset pulse width of 130 ms minimum.

The third function is a watchdog timer. The DS1705/DS1706 has an internal timer that forces the \overline{WDS} output signal to the active state if the strobe input is not driven low prior to time-out.

OPERATION

Power Monitor

The DS1705/DS1706 detects out-of-tolerance power supply conditions and warns a processor-based system of impending power failure. When V_{CC} falls below the minimum V_{CC} tolerance, a comparator outputs the \overline{RST} (or RST) signal. \overline{RST} (or RST) is an excellent control signal for a microprocessor, as processing is stopped at the last possible moment of valid V_{CC} . On power-up, \overline{RST} (or RST) are kept active for a minimum of 130 ms to allow the power supply and processor to stabilize.

Pushbutton Reset

The DS1705/DS1706 provides an input pin for direct connection to a pushbutton reset (see Figure 2). The pushbutton reset input requires an active low signal. Internally, this input is debounced and timed such that a \overline{RST} (or RST) signal of at least 130 ms minimum will be generated. The 130 ms delay commences as the pushbutton reset input is released from the low level. The pushbutton can be initiated by connecting the \overline{WDS} or \overline{NMI} outputs to the \overline{PBRST} input as shown in Figure 3.

Non-Maskable Interrupt

The DS1705/DS1706 generates a non-maskable interrupt (\overline{NMI}) for early warning of a power failure. A precision comparator monitors the voltage level at the IN pin relative to an on-chip reference generated by an internal band gap. The IN pin is a high impedance input allowing for a user-defined sense point. An external resistor voltage divider network (Figure 5) is used to interface with high voltage signals. This sense point may be derived from a regulated supply or from a higher DC voltage level closer to the main system power input. Since the IN trip point V_{TP} is 1.25 volts, the proper values for R1 and R2 can be determined by the equation as shown in Figure 5. Proper operation of the DS1705/DS1706 requires that the voltage at the IN pin be limited to V_{CC} . Therefore, the maximum allowable voltage at the supply being monitored (V_{MAX}) can also be derived as shown in Figure 5. A simple approach to solving the equation is to select a value for R2 high enough to keep power consumption low, and solve for R1. The flexibility of the IN input pin allows for detection of power loss at the earliest point in a power supply system, maximizing the amount of time for system shutdown between \overline{NMI} and \overline{RST} (or RST).

When the supply being monitored decays to the voltage sense point, the DS1705/DS1706 pulses the \overline{NMI} output to the active state for a minimum 200 μ s. The \overline{NMI} power-fail detection circuitry also has built-in hysteresis of 100 μ V. The supply must be below the voltage sense point for approximately 5 μ s before a low \overline{NMI} will be generated. In this way, power supply noise is removed from the monitoring function, preventing false interrupts. During a power-up, any detected IN pin levels below V_{TP} by the comparator are disabled from generating an interrupt until V_{CC} rises to V_{CCTP} . As a result, any potential \overline{NMI} pulse will not be initiated until V_{CC} reaches V_{CCTP} .

Connecting \overline{NMI} to \overline{PBRST} would allow non-maskable interrupt to generate an automatic reset when an out-of-tolerance condition occurred in a monitored supply. An example is shown in Figure 3.

ABSOLUTE MAXIMUM RATINGS*

Voltage on V _{CC} Pin Relative to Ground	-0.5V to +7.0V
Voltage on I/O Relative to Ground**	-0.5V to V _{CC} + 0.5V
Operating Temperature	-40°C to +85°C
Storage Temperature	-55°C to +125°C
Soldering Temperature	260°C for 10 seconds

* This is a stress rating only and functional operation of the device at these or any other conditions above those indicated in the operation sections of this specification is not implied. Exposure to absolute maximum rating conditions for extended periods of time may affect reliability.

** The voltage input on IN, ST, and $\overline{\text{PBRST}}$ can be exceeded if the input current is less than 10 mA.

RECOMMENDED DC OPERATING CONDITIONS (-40°C to +85°C)

PARAMETER	SYMBOL	MIN	TYP	MAX	UNITS	NOTES
Supply Voltage	V _{CC}	1.2		5.5	V	1
$\overline{\text{ST}}$ and $\overline{\text{PBRST}}$ Input High Level	V _{IH}	2.0 V _{CC} -0.5		V _{CC} +0.3	V	1, 3 1, 4
$\overline{\text{ST}}$ and $\overline{\text{PBRST}}$ Input Low Level	V _{IL}	-0.03		+0.5	V	1

DC ELECTRICAL CHARACTERISTICS (-40°C to +85°C; V_{CC}=1.2V to 5.5V)

PARAMETER	SYMBOL	MIN	TYP	MAX	UNITS	NOTES
V _{CC} Trip Point DS1705/DS1706L	V _{CC} TP	4.50	4.65	4.75	V	1
V _{CC} Trip Point DS1706	V _{CC} TP	4.25	4.40	4.50	V	1
V _{CC} Trip Point DS1706T	V _{CC} TP	3.00	3.08	3.15	V	1
V _{CC} Trip Point DS1706S	V _{CC} TP	2.85	2.93	3.00	V	1
V _{CC} Trip Point DS1706P or R	V _{CC} TP	2.55	2.63	2.70	V	1
Input Leakage	I _{IL}	-1.0		+1.0	μA	2
Output Current @ 2.4V	I _{OH}		350		μA	3
Output Current @ 0.4V	I _{OL}	10			mA	3
Output Voltage @ -500 μA	V _{OH}	V _{CC} -0.3	V _{CC} -0.1		V	3
Operating Current @ V _{CC} < 5.5V	I _{CC}			60	μA	5
Operating Current @ V _{CC} < 3.6V	I _{CC}			50	μA	5
IN Input Trip Point	V _{TP}	1.20	1.25	1.30	V	1

CAPACITANCE (t_A=258C)

PARAMETER	SYMBOL	MIN	TYP	MAX	UNITS	NOTES
Input Capacitance	C _{IN}			5	pF	
Output Capacitance	C _{OUT}			7	pF	

AC ELECTRICAL CHARACTERISTICS (-40°C to +85°C; $V_{CC}=1.2V$ to $5.5V$)

PARAMETER	SYMBOL	MIN	TYP	MAX	UNITS	NOTES
$\overline{PBRST} = V_{IL}$	t_{PB}	150			ns	
Reset Active Time	t_{RST}	130	205	285	ms	
\overline{ST} Pulse Width	t_{ST}	10			ns	6
V_{CC} Detect to RST and \overline{RST}	t_{RPD}		5	8	μs	9
V_{CC} Slew Rate	t_F	20			μs	
V_{CC} Detect to RST and \overline{RST}	t_{RPU}	130	205	285	ms	7
V_{CC} Slew Rate	t_R	0			ns	
\overline{PBRST} Stable Low to RST and \overline{RST}	t_{PDLY}			250	ns	
Watchdog Timeout	t_{TD}	1.0	1.6	2.2	s	8
V_{IN} Detect to \overline{NMI}	t_{IPD}		5	8	μs	9

NOTES:

- All voltages are referenced to ground.
- \overline{PBRST} is internally pulled up to V_{CC} with an internal impedance of 40 k Ω typical and the \overline{ST} input is internally pulled up to V_{CC} with an internal impedance of 180 k Ω typical.
- $V_{CC} \geq 2.4V$.
- $V_{CC} < 2.4V$.
- Measured with outputs open and all inputs at V_{CC} or ground.
- Must not exceed t_{TD} minimum.
- $t_R = 5 \mu s$.
- Minimum watchdog time-out tested at 2.7V for the 3.3V devices and 4.5V for the 5.0V devices.
- Noise immunity – pulses $< 2 \mu s$ at V_{CCTP} minimum will not cause a reset.

ORDERING INFORMATION

ORDERING NUMBER	PACKAGE	OPERATING TEMPERATURE	VERSION
DS1705EPA	8-pin DIP (300mil)	-40°C TO +85°C	5V-5% MONITOR, /RST, /WDS
DS1705ESA	8-pin SOIC (150 mil)	-40°C TO +85°C	5V-5% MONITOR, /RST, /WDS
DS1705EUA	8-pin μ SOP (118 mil)	-40°C TO +85°C	5V-5% MONITOR, /RST, /WDS
DS1706EPA	8-pin DIP (300mil)	-40°C TO +85°C	5V-10% MONITOR, /RST, /WDS
DS1706ESA	8-pin SOIC (150 mil)	-40°C TO +85°C	5V-10% MONITOR, /RST, /WDS
DS1706EUA	8-pin μ SOP (118 mil)	-40°C TO +85°C	5V-10% MONITOR, /RST, /WDS
DS1706LEPA	8-pin DIP (300mil)	-40°C TO +85°C	5V-5% MONITOR, RST, /WDS
DS1706LESA	8-pin SOIC (150 mil)	-40°C TO +85°C	5V-5% MONITOR, RST, /WDS
DS1706LEUA	8-pin μ SOP (118 mil)	-40°C TO +85°C	5V-5% MONITOR, RST, /WDS
DS1706PEPA	8-pin DIP (300mil)	-40°C TO +85°C	3.3V-20% MONITOR, RST, /WDS
DS1706PESA	8-pin SOIC (150 mil)	-40°C TO +85°C	3.3V-20% MONITOR, RST, /WDS
DS1706PEUA	8-pin μ SOP (118 mil)	-40°C TO +85°C	3.3V-20% MONITOR, RST, /WDS
DS1706REPA	8-pin DIP (300mil)	-40°C TO +85°C	3.3V-20% MONITOR, /RST, /WDS
DS1706RESA	8-pin SOIC (150 mil)	-40°C TO +85°C	3.3V-20% MONITOR, /RST, /WDS
DS1706REUA	8-pin μ SOP (118 mil)	-40°C TO +85°C	3.3V-20% MONITOR, /RST, /WDS
DS1706SEPA	8-pin DIP (300mil)	-40°C TO +85°C	3.3V-10% MONITOR, /RST, /WDS
DS1706SESA	8-pin SOIC (150 mil)	-40°C TO +85°C	3.3V-10% MONITOR, /RST, /WDS
DS1706SEUA	8-pin μ SOP (118 mil)	-40°C TO +85°C	3.3V-10% MONITOR, /RST, /WDS
DS1706TEPA	8-pin DIP (300mil)	-40°C TO +85°C	3.3V-5% MONITOR, /RST, /WDS
DS1706TESA	8-pin SOIC (150 mil)	-40°C TO +85°C	3.3V-5% MONITOR, /RST, /WDS
DS1706TEUA	8-pin μ SOP (118 mil)	-40°C TO +85°C	3.3V-5% MONITOR, /RST, /WDS

* Contact factory for availability of Pb-free versions.

E = -40°C to +85°C temperature range

A = 8 lead device

P = Plastic DIP (300 mil)

S = SOIC (150 mil)

U = μ SOP (118 mil)

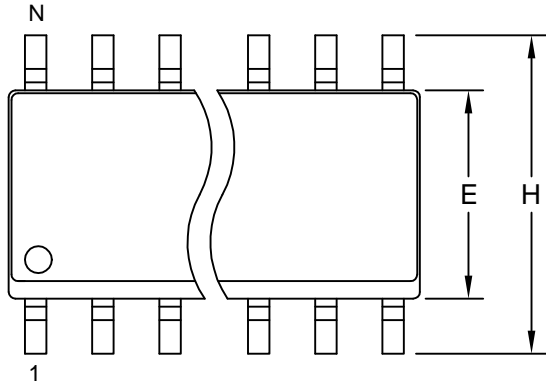

TOP VIEW

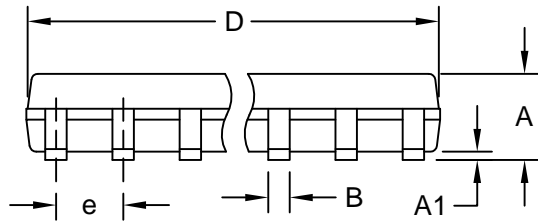

FRONT VIEW

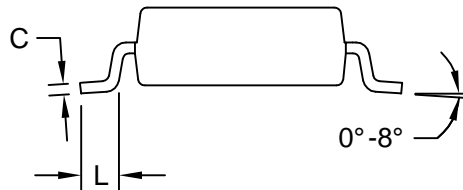

SIDE VIEW

DIM	INCHES		MILLIMETERS	
	MIN	MAX	MIN	MAX
A	0.053	0.069	1.35	1.75
A1	0.004	0.010	0.10	0.25
B	0.014	0.019	0.35	0.49
C	0.007	0.010	0.19	0.25
e	0.050 BSC		1.27 BSC	
E	0.150	0.157	3.80	4.00
H	0.228	0.244	5.80	6.20
L	0.016	0.050	0.40	1.27

VARIATIONS:

DIM	INCHES		MILLIMETERS		N	MS012
	MIN	MAX	MIN	MAX		
D	0.189	0.197	4.80	5.00	8	AA
D	0.337	0.344	8.55	8.75	14	AB
D	0.386	0.394	9.80	10.00	16	AC

NOTES:

1. D&E DO NOT INCLUDE MOLD FLASH.
2. MOLD FLASH OR PROTRUSIONS NOT TO EXCEED 0.15mm (.006").
3. LEADS TO BE COPLANAR WITHIN 0.10mm (.004").
4. CONTROLLING DIMENSION: MILLIMETERS.
5. MEETS JEDEC MS012.
6. N = NUMBER OF PINS.

PROPRIETARY INFORMATION			
TITLE: PACKAGE OUTLINE, .150" SOIC			
APPROVAL	DOCUMENT CONTROL NO. 21-0041	REV. B	1/1

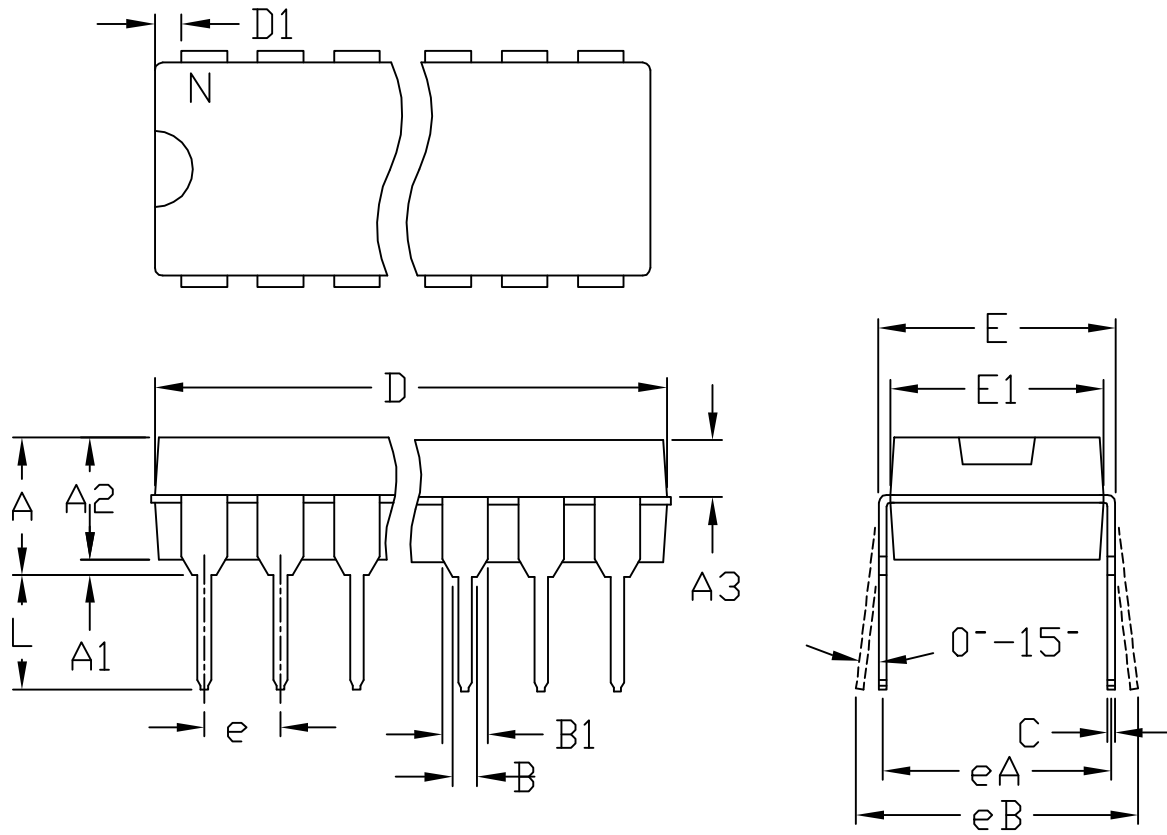

	INCHES		MILLIMETERS	
	MIN	MAX	MIN	MAX
A	---	0.180	---	4.572
A1	0.015	---	0.38	---
A2	0.125	0.175	3.18	4.45
A3	0.055	0.080	1.40	2.03
B	0.015	0.022	0.381	0.56
B1	0.045	0.065	1.14	1.65
C	0.008	0.014	0.2	0.355
D1	0.005	0.080	0.13	2.03
E	0.300	0.325	7.62	8.26
E1	0.240	0.310	6.10	7.87
e	0.100	BSC.	2.54	BSC.
eA	0.300	BSC.	7.62	BSC.
eB	0.400	BSC.	10.16	BSC.
L	0.115	0.150	2.921	3.81

	INCHES		MILLIMETERS		N	MS001
	MIN	MAX	MIN	MAX		
D	0.348	0.390	8.84	9.91	8	AB
D	0.735	0.765	18.67	19.43	14	AC
D	0.745	0.765	18.92	19.43	16	AA
D	0.885	0.915	22.48	23.24	18	AD
D	1.015	1.045	25.78	26.54	20	AE
D	1.14	1.265	28.96	32.13	24	AF
D	1.360	1.380	34.54	35.05	28	*5

- NOTES:
1. D&E DO NOT INCLUDE MOLD FLASH
 2. MOLD FLASH OR PROTRUSIONS NOT TO EXCEED .15mm (.006")
 3. CONTROLLING DIMENSION: MILLIMETER
 4. MEETS JEDEC MS001-XX AS SHOWN IN ABOVE TABLE
 5. SIMILIAR TO JEDEC MO-058AB
 6. N = NUMBER OF PINS